

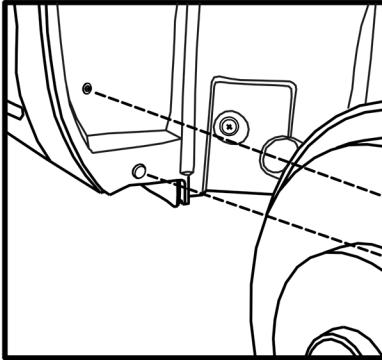

Mudflaps front FORD Fiesta, sed. 2015->





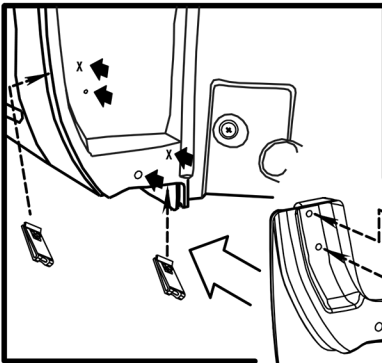

Preparation

- 1x  Original screw
- 1x  Original plastic rivet



Installation

- 1x  Original screw
- 1x  Plastic rivet 8 mm
- 2x  Screw $\varnothing 4,2 \times 16$ mm
- 2x  Spring

1x  Washer

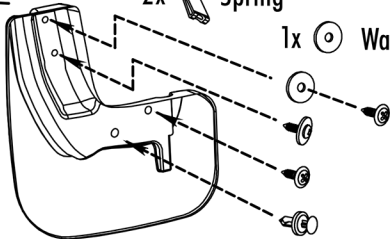

Art.:EXP.NLF.16.69.F10

Set Package

Mudflap - 2 pcs. Screw $\varnothing 4,2 \times 16$ mm - 4 pcs.
Plastic rivet 8 mm - 2 pcs. Spring- 4 шт. Washer- 2 шт.